

Pendant system luminaire. Aluminum profile incl. LED-unit, 90° L-shaped, naturally anodised. Housing colour black RAL 9005. Direct/indirect distribution. Constant indirect share via white-opal, satin-finished acrylic diffusor throughout all system components. Direct share via white-opal, satin finished acrylic endless diffusor serio-G. Feed-in and through wiring plug-in system 10A. For system profile serio-HIT LB one wire suspension is in scope of delivery. Available accessories: face-ends with wire suspension incl. connection cord and canopy set serio-HITE LED A/E Set 3x0,75 sw (5430137104); connection cord serio-AL 3x0,75 (5430037105); endless diffusor 6m serio-G/06000 LED (5430600180); 10m serio-G/10000 LED (5431000180); 20m serio-G/20000 LED (5432000180);

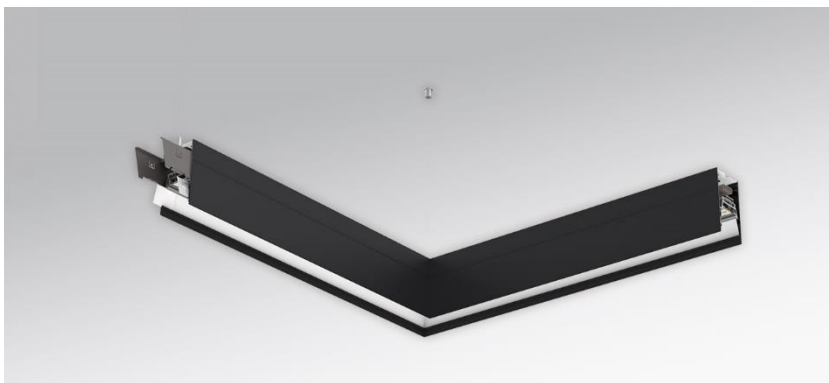

- Article No.: 5434044114
- Housing material: Aluminium
- Housing colour: black RAL 9005
- Light distribution: direct/indirect distribution
- Type of installation: Pendant light strip mounting
- Certification mark: IP 20, Protection class I, F, Indoor, CE

Dimensions

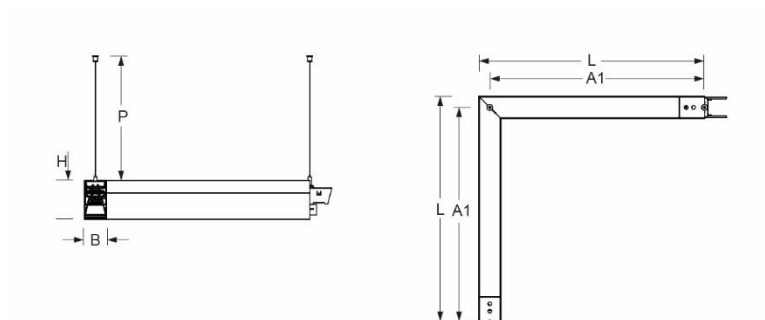

- Dimensions LxWxH/DxH: 615 x 61 x 106 (mm)
- Pendant length min/max: 150 / 2000 (mm)
- Mounting distance A1: 585 (mm)
- Weight (net): 4.3 (kg)

Lighting/Electrical

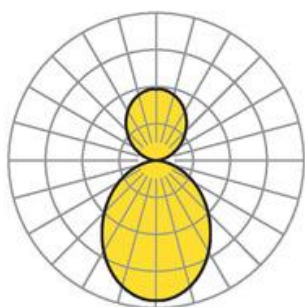

- Placement: LED, Colour rendering/Light colour CRI ≥ 80 / 4000K
- Direct/Indirect: 64 % / 36 %
- UGR lat/lon: 14.2 / 14.2
- Luminaire luminous flux: 3200 (lm)
- LED service life: 50000h L80/B10 (Tq 25°C)
- Luminaire luminous efficacy: 123 (lm/W)
- System output: 26 (W)
- Controller: Electronic driver (1 pcs.)
- Mains voltage max.: 230 V / 50 Hz
- Driver/Breaker: 21 pieces/B10
34 pieces/B16|35 pieces/C10|57 pieces/C16
- Energy efficiency class: C