

Recessed system luminaire. Aluminium profile formed as 90° angle, natural anodised, with white reflectors, for cut-out ceilings. Housing colour aluminium, naturally anodised. Flat translucent polycarbonate extruded profile, with inserted microprismatic diffusor, mitre cut, self-engaging. Electrical connection via five-pole feed-in and connection terminal with plug-in technology, with integrated protective earth connection and unlocking button, suitable for rigid and flexible cables up to 2,5mm². Through wiring plug-in system 10A. Mounting via swivel bracket or wire suspension. Available accessories: Face-end set fino-ETE (K/MP) (1350110105); 1 set swivel bracket fino ETB (1350002105) or 1 set wire suspension to bare ceiling fino-ETS (1350080105);

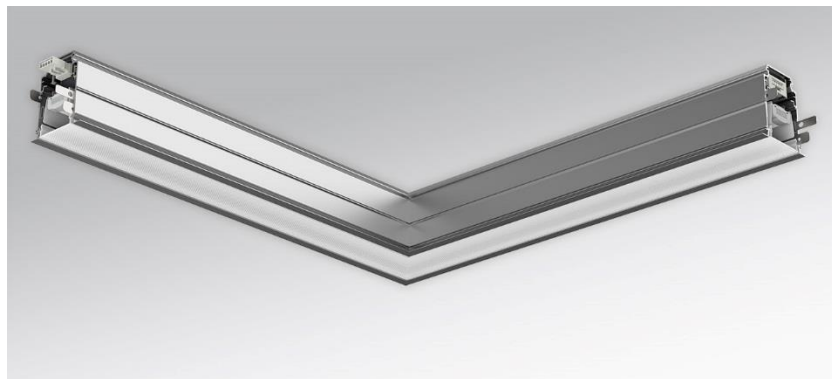

- Article No.: 1354044125+1350600150
- Housing material: Aluminium
- Housing colour: aluminium, naturally anodised
- Light distribution: direct distribution
- Type of installation: Installation of light run installations
- Certification mark: IP 20, Protection class I, F, Indoor, CE

Dimensions

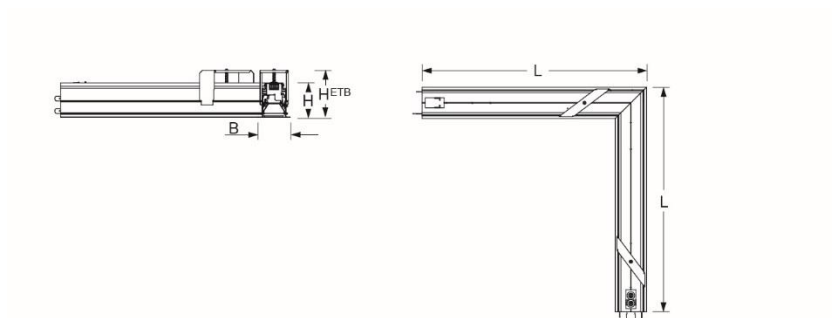

- Dimensions LxWxH/DxH: 619 x 86 x 96 (mm)
- Ceiling cut-out LxW/D: 614 x 77 (mm)
- Ceiling thickness min/max: 11 / 30 (mm)
- Installation depth: 135(AD) (mm)
- Weight (net): 3.8 (kg)

Lighting/Electrical

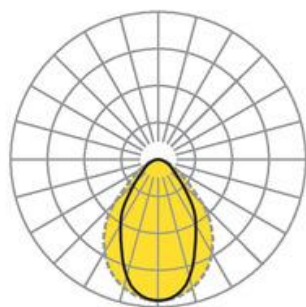

- Placement: LED, Colour rendering/Light colour CRI ≥ 80 / 4000K
- Direct/Indirect: 100 % / 0 %
- UGR lat/lon: 17.4 / 19.2
- Luminaire luminous flux: 1600 (lm)
- LED service life: L80/B10 50000
- Luminaire luminous efficacy: 114 (lm/W)
- System output: 7 (W)
- Controller: Electronic driver (1 pcs.)
- Mains voltage max.: 230 V / 50 Hz