

Surface-mounted system luminaire. Aluminium profile formed as 90° angle, natural anodised with white reflector and separate mounting rail. Housing colour aluminium, naturally anodised. Flat white-opal frosted, extruded profile made from polycarbonate; mitre cut; self-engaging. Electrical connection via five-pole feed-in and connection terminal with plug-in technology, with integrated protective earth connection and unlocking button, suitable for rigid and flexible cables up to 2,5mm<sup>2</sup>. Through wiring plug-in system 10A. Available accessories: Face-end set fino-ATE (K/MP) (435 0110 105), five-pole connection terminal fino-ALK 5x0,75mm<sup>2</sup> (435 0057 105).

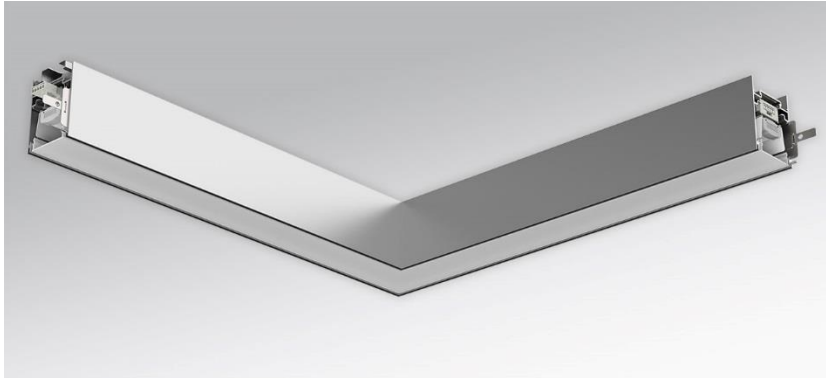

- Article No.: 4354046625+1350600180
- Housing material: Aluminium
- Housing colour: aluminium, naturally anodised
- Light distribution: direct distribution
- Type of installation: Surface-mounted light run installation
- Certification mark: IP 20, Protection class I, F, Indoor, CE

## Dimensions

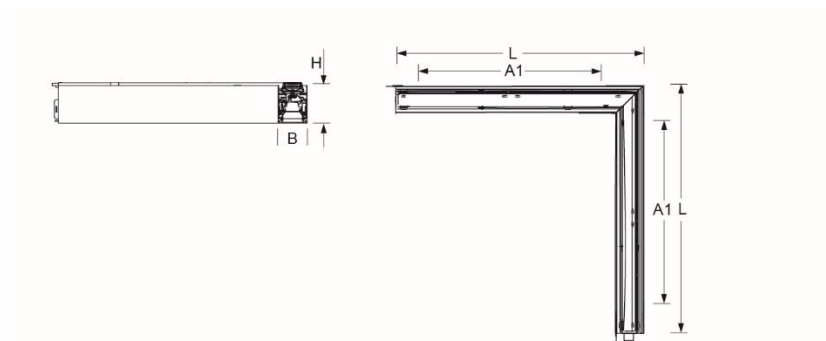

- Dimensions LxWxH/DxH: 612 x 72 x 102 (mm)
- Mounting distance A1: 436 (mm)
- Mounting distance A2: 280 (mm)
- Weight (net): 4.7 (kg)

## Lighting/Electrical



- Placement: LED, Colour rendering/Light colour CRI  $\geq 80$  / 4000K
- Direct/Indirect: 100 % / 0 %
- UGR lat/lon: 22.5 / 22.5
- Luminaire luminous flux: 1400 (lm)
- LED service life: L80/B10 50000
- Luminaire luminous efficacy: 99 (lm/W)
- System output: 7 (W)
- Controller: Electronic driver DALI (1 pcs.)
- Mains voltage max.: 230 V / 50 Hz