

Surface-mounted luminaire. Round aluminium profile, texture painted. Suitable for ceiling mounting. Housing colour black RAL 9005. Direct/indirect distribution. Light distribution via microprismatic panel with conical glare elimination in multilayer technology. For VDU workstations $65^\circ < 3000\text{cd/m}^2$, $\text{UGR} \leq 19$ according to DIN EN 12464-1. Indirect ratio for a smooth ceiling illumination. Electrical connection via three-pole feed-in and connection terminal with plug-in technology, with integrated protective earth connection and unlocking button, suitable for rigid and flexible cables up to 2,5mm². Easy mounting due to bayonet lock and plug & play connection.

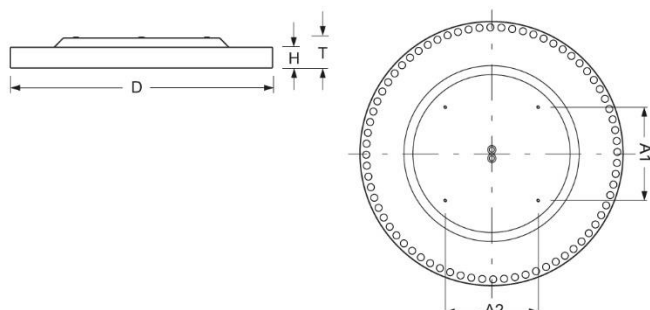

- Article No.: 4679044154
- Housing material: Aluminium
- Housing colour: black RAL 9005
- Light distribution: direct/indirect distribution
- Type of installation: Individual surface mounting
- Certification mark: IP 20, Protection class I, VDU $65^\circ < 3000$, Indoor, CE

Dimensions



- Dimensions LxWxH/DxH: 880 x 69 (mm)
- Depth: 102 (mm)
- Mounting distance A1: 311 (mm)
- Mounting distance A2: 311 (mm)
- Weight (net): 14 (kg)

Lighting/Electrical

- Placement: LED, Colour rendering/Light colour CRI ≥ 80 / 4000K
- Direct/Indirect: 98 % / 2 %
- UGR lat/lon: 19.0 / 19.0
- Luminaire luminous flux: 8800 (lm)
- LED service life: 050000h L80/B10
- Luminaire luminous efficacy: 153 (lm/W)
- System output: 57 (W)
- Controller: Electronic driver (1 pcs.)
- Mains voltage max.: 230 V / 50 Hz
- Energy efficiency class: C