

Surface-mounted luminaire. Round aluminium profile, texture painted. Suitable for ceiling and wall mounting. Housing colour black RAL 9005. Direct/indirect distribution. Homogenous illumination by satinised special acrylic pane with high transmission. Indirect ratio for a smooth ceiling/wall illumination. Electrical connection via five-pole feed-in and connection terminal with plug-in technology, with integrated protective earth connection and unlocking button, suitable for rigid and flexible cables up to 2,5mm². Easy mounting due to bayonet lock and plug & play connection.

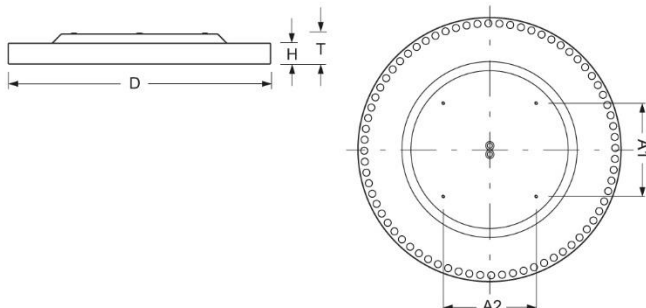

- Article No.: 4679136684
- Housing material: Aluminium
- Housing colour: black RAL 9005
- Light distribution: direct/indirect distribution
- Type of installation: Individual surface mounting
- Certification mark: IP 20, Protection class I, Indoor, CE

Dimensions



- Dimensions LxWxH/DxH: 880 x 69 (mm)
- Depth: 102 (mm)
- Mounting distance A1: 311 (mm)
- Mounting distance A2: 311 (mm)
- Weight (net): 14 (kg)

Lighting/Electrical



- Placement: LED, Colour rendering/Light colour CRI ≥ 80 / 3000K
- Direct/Indirect: 99 % / 1 %
- UGR lat/lon: 23.3 / 23.3
- Luminaire luminous flux: 13700 (lm)
- LED service life: 050000h L80/B10
- Luminaire luminous efficacy: 150 (lm/W)
- System output: 91 (W)
- Controller: Electronic driver DALI (1 pcs.)
- Mains voltage max.: 230 V / 50 Hz
- Energy efficiency class: C