

Surface-mounted luminaire. Round aluminium profile, texture painted. Suitable for ceiling mounting. Housing colour traffic white RAL 9016. Direct distribution. Light distribution via microprismatic panel with conical glare elimination in multilayer technology. For VDU workstations  $65^\circ < 3000\text{cd/m}^2$ ,  $\text{UGR} \leq 19$  according to DIN EN 12464-1. Electrical connection via three-pole feed-in and connection terminal with plug-in technology, with integrated protective earth connection and unlocking button, suitable for rigid and flexible cables up to  $2,5\text{mm}^2$ . Easy mounting due to bayonet lock and plug & play connection.

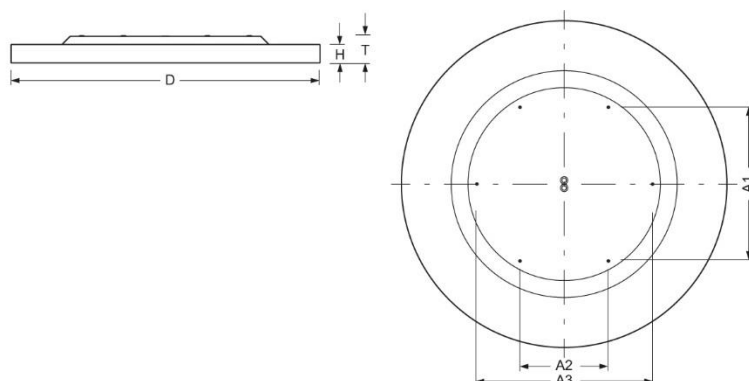

- Article No.: 4681044150
- Housing material: Aluminium
- Housing colour: traffic white RAL 9016
- Light distribution: direct distribution
- Type of installation: Individual surface mounting
- Certification mark: IP 20, Protection class I, VDU  $65^\circ < 3000$ , Indoor, CE

## Dimensions



- Dimensions LxWxH/DxH: 1160 x 69 (mm)
- Depth: 102 (mm)
- Mounting distance A1: 546 (mm)
- Mounting distance A2: 315 (mm)
- Mounting distance A3: 630 (mm)
- Weight (net): 25.6 (kg)

## Lighting/Electrical

- Placement: LED, Colour rendering/Light colour CRI  $\geq 80$  / 4000K
- Direct/Indirect: 100 % / 0 %
- UGR lat/lon: 19.0 / 19.0
- Luminaire luminous flux: 14800 (lm)
- LED service life: 050000h L80/B10
- Luminaire luminous efficacy: 150 (lm/W)
- System output: 99 (W)
- Controller: Electronic driver (2 pcs.)
- Mains voltage max.: 230 V / 50 Hz
- Energy efficiency class: C