

Surface-mounted luminaire. Round aluminium profile, texture painted. Suitable for ceiling mounting. Housing colour traffic white RAL 9016. Direct/indirect distribution. Light distribution via microprismatic panel with conical glare elimination in multilayer technology. For VDU workstations $65^\circ < 3000\text{cd/m}^2$, $\text{UGR} \leq 19$ according to DIN EN 12464-1. Indirect ratio for a smooth ceiling illumination. Electrical connection via three-pole feed-in and connection terminal with plug-in technology, with integrated protective earth connection and unlocking button, suitable for rigid and flexible cables up to 2,5mm². Easy mounting due to bayonet lock and plug & play connection.

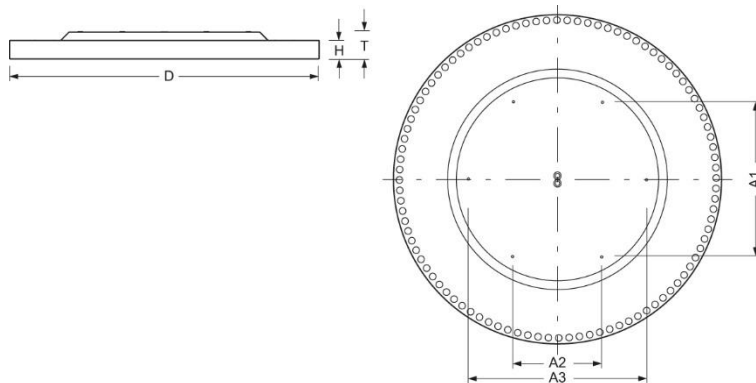

- Article No.: 4671034150
- Housing material: Aluminium
- Housing colour: traffic white RAL 9016
- Light distribution: direct/indirect distribution
- Type of installation: Individual surface mounting
- Certification mark: IP 20, Protection class I, VDU $65^\circ < 3000$, Indoor, CE

Dimensions



- Dimensions LxWxH/DxH: 1160 x 69 (mm)
- Depth: 102 (mm)
- Mounting distance A1: 546 (mm)
- Mounting distance A2: 315 (mm)
- Mounting distance A3: 630 (mm)
- Weight (net): 25.6 (kg)

Lighting/Electrical

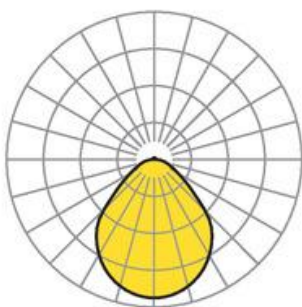

- Placement: LED, Colour rendering/Light colour CRI ≥ 80 / 3000K
- Direct/Indirect: 98 % / 2%
- UGR lat/lon: 18.7 / 18.7
- Luminaire luminous flux: 14400 (lm)
- LED service life: 050000h L80/B10
- Luminaire luminous efficacy: 146 (lm/W)
- System output: 99 (W)
- Controller: Electronic driver (2 pcs.)
- Mains voltage max.: 230 V / 50 Hz
- Energy efficiency class: C