

Pendant luminaire. Round aluminium profile, texture painted. 3 wire suspension for all ciros R-H diameters. Ceiling cylinder for horizontal ceilings. Housing colour traffic white RAL 9016. Direct/indirect distribution. Light distribution via microprismatic panel with conical glare elimination in multilayer technology. For VDU workstations  $65^\circ < 3000\text{cd/m}^2$ ,  $\text{UGR} \leq 19$  according to DIN EN 12464-1. Indirect ratio by separate LED's with satinised special acrylic pane. Separately DALI dimmable. Electrical connection via translucent connection cord,  $3 \times 0.75\text{mm}^2$ , 2300mm. Ceiling canopy plastic, white,  $D=72\text{mm}$ ,  $H=22\text{mm}$  incl. cable clips for wire suspension, transparent. Easy mounting due to bayonet lock and plug & play connection.

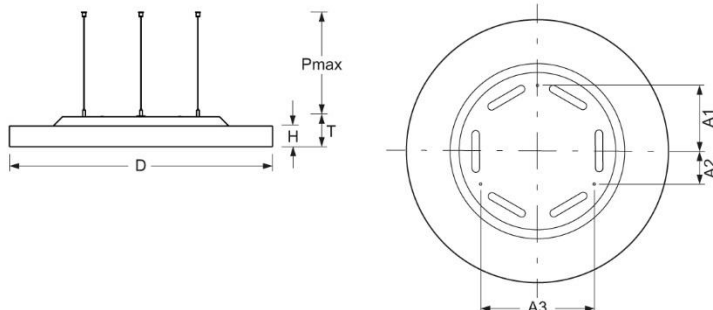

- Article No.: 5679044150+5670057100
- Housing material: Aluminium
- Housing colour: traffic white RAL 9016
- Light distribution: direct/indirect distribution
- Type of installation: Pendant individual mounting
- Certification mark: IP 20, Protection class I, VDU  $65^\circ < 3000$ , Indoor, CE

## Dimensions



- Dimensions LxWxH/DxH: 880 x 69 (mm)
- Depth: 100 (mm)
- Pendant length min/max: 200 / 2000 (mm)
- Mounting distance A1: 220 (mm)
- Mounting distance A2: 110 (mm)
- Mounting distance A3: 381 (mm)
- Weight (net): 8.2 (kg)
- Cable entry KE X/Y: 0 (mm) / 0 (mm)

## Lighting/Electrical

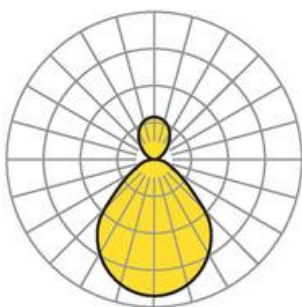

- Placement: LED, Colour rendering/Light colour CRI  $\geq 80$  / 4000K
- Direct/Indirect: 77 % / 23 %
- UGR lat/lon: 17.3 / 17.3
- Luminaire luminous flux: 11100 (lm)
- LED service life: 50000h L80/B10
- Luminaire luminous efficacy: 141 (lm/W)
- System output: 79 (W)
- Controller: Electronic driver (2 pcs.)
- Mains voltage max.: 230 V / 50 Hz