

Pendant luminaire. Round aluminium profile, texture painted. Rod suspension for ciros R900-H including ceiling canopy 130mm x 45mm made of aluminium, texture painted. For horizontal ceilings. Safety wire rod integrated. Rod can be shortened on site. Housing colour black RAL 9005. Direct/indirect distribution. Light distribution via microprismatic panel with conical glare elimination in multilayer technology. For VDU workstations $65^\circ < 3000\text{cd/m}^2$, $\text{UGR} \leq 19$ according to DIN EN 12464-1. Indirect ratio by separate LED's with satinised special acrylic pane. Separately DALI dimmable. Electrical connection via five-pole feed-in and connection terminal with plug-in technology, with integrated protective earth connection and unlocking button, suitable for rigid and flexible cables up to $2,5\text{mm}^2$. Easy mounting due to bayonet lock and plug & play connection.

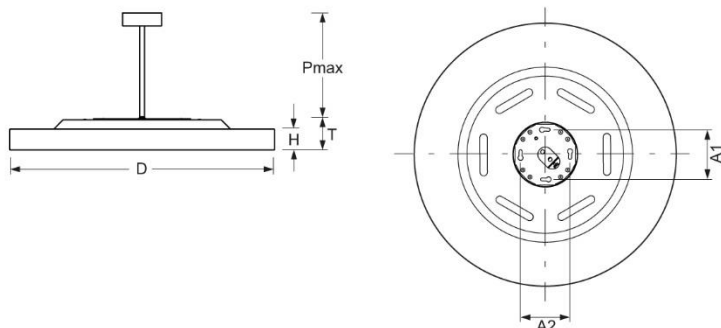

- Article No.: 5679074154+5679957104
- Housing material: Aluminium
- Housing colour: black RAL 9005
- Light distribution: direct/indirect distribution
- Type of installation: Pendant individual mounting
- Certification mark: IP 20, Protection class I, VDU $65^\circ < 3000$, Indoor, CE

Dimensions



- Dimensions LxWxH/DxH: 880 x 69 (mm)
- Depth: 100 (mm)
- Pendant length min/max: 300 / 1000 (mm)
- Mounting distance A1: 100 (mm)
- Mounting distance A2: 100 (mm)
- Weight (net): 17.4 (kg)
- Cable entry KE X/Y: 0 (mm) / 0 (mm)

Lighting/Electrical

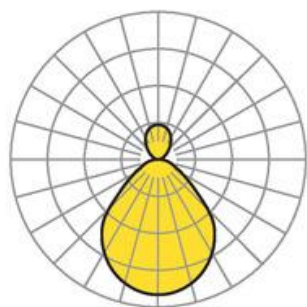

- Placement: LED, Colour rendering/Light colour CRI ≥ 90 / 4000K
- Direct/Indirect: 81 % / 19 %
- UGR lat/lon: 17.5 / 17.5
- Luminaire luminous flux: 10300 (lm)
- LED service life: 50000h L80/B10
- Luminaire luminous efficacy: 122 (lm/W)
- System output: 85 (W)
- Controller: Electronic driver (2 pcs.)
- Mains voltage max.: 230 V / 50 Hz