

Pendant luminaire. Round aluminium profile, texture painted. Triangle suspension for ciros R600-H including ceiling canopy 130mm x 45mm made of aluminium, texture painted and safety wire. For horizontal ceilings. Housing colour white aluminium RAL 9006. Direct/indirect distribution. Homogenous illumination by satinised special acrylic pane with high transmission. Indirect ratio by separate LED's with satinised special acrylic pane. Separately DALI dimmable. Electrical connection via five-pole feed-in and connection terminal with plug-in technology, with integrated protective earth connection and unlocking button, suitable for rigid and flexible cables up to 2,5mm². Easy mounting due to bayonet lock and plug & play connection.

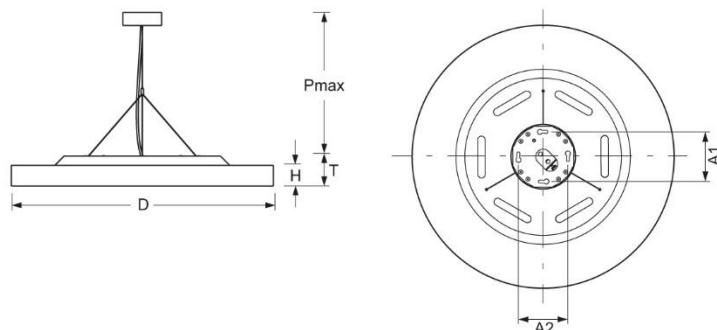

- Article No.: 5679134186+5679357106
- Housing material: Aluminium
- Housing colour: white aluminium RAL 9006
- Light distribution: direct/indirect distribution
- Type of installation: Pendant individual mounting
- Certification mark: IP 20, Protection class I, Indoor, CE

Dimensions



- Dimensions LxWxH/DxH: 880 x 69 (mm)
- Depth: 100 (mm)
- Pendant length min/max: 300 / 2000 (mm)
- Mounting distance A1: 100 (mm)
- Mounting distance A2: 100 (mm)
- Weight (net): 15.9 (kg)
- Cable entry KE X/Y: 0 (mm) / 0 (mm)

Lighting/Electrical



- Placement: LED, Colour rendering/Light colour CRI ≥ 80 / 3000K
- Direct/Indirect: 79 % / 21 %
- UGR lat/lon: 21.8 / 21.8
- Luminaire luminous flux: 17200 (lm)
- LED service life: 50000h L80/B10
- Luminaire luminous efficacy: 135 (lm/W)
- System output: 128 (W)
- Controller: Electronic driver (2 pcs.)
- Mains voltage max.: 230 V / 50 Hz