

Pendant luminaire. Round aluminium profile, texture painted. 3 wire suspension for all ciros R-H diameters. Ceiling cylinder for horizontal ceilings. Housing colour traffic white RAL 9016. Direct/indirect distribution. Homogenous illumination by satinised special acrylic pane with high transmission. Indirect ratio by separate LED's with satinised special acrylic pane. Separately DALI dimmable. Electrical connection via translucent connection cord, 3x0.75mm<sup>2</sup>, 2300mm. Ceiling canopy plastic, white, D=72mm, H=22mm incl. cable clips for wire suspension, transparent. Easy mounting due to bayonet lock and plug & play connection.

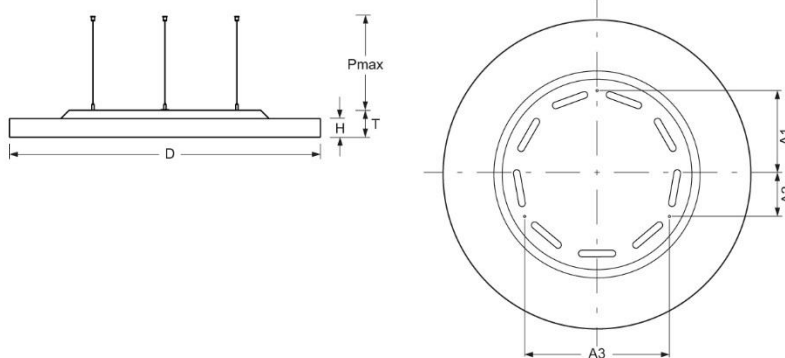

- Article No.: 5671174180+5670057100
- Housing material: Aluminium
- Housing colour: traffic white RAL 9016
- Light distribution: direct/indirect distribution
- Type of installation: Pendant individual mounting
- Certification mark: IP 20, Protection class I, Indoor, CE

## Dimensions



- Dimensions LxWxH/DxH: 1160 x 69 (mm)
- Depth: 100 (mm)
- Pendant length min/max: 200 / 2000 (mm)
- Mounting distance A1: 310 (mm)
- Mounting distance A2: 155 (mm)
- Mounting distance A3: 537 (mm)
- Weight (net): 27.9 (kg)
- Cable entry KE X/Y: 0 (mm) / 0 (mm)

## Lighting/Electrical

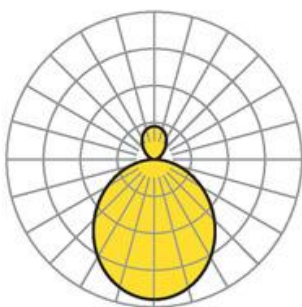

- Placement: LED, Colour rendering/Light colour CRI ≥ 90 / 4000K
- Direct/Indirect: 85 % / 15 %
- UGR lat/lon: 22.7 / 22.7
- Luminaire luminous flux: 31900 (lm)
- LED service life: 50000h L80/B10
- Luminaire luminous efficacy: 128 (lm/W)
- System output: 249 (W)
- Controller: Electronic driver (3 pcs.)
- Mains voltage max.: 230 V / 50 Hz