

lichtwerk
inspired by light

21
22

Table structure

The tabular structure enables an overview of the essential features.

Type
Designation of the luminaire

LED Specification
Luminous flux lumen (lm)
Colour rendering index RA
Colour temperature Kelvin (K)

NEW

Item-number → the last digit of the article number indicates the housing colour
543 3044 10... → ...1

Luminaire weight net (without packaging)

Type	LED Specification	P _{sys} (W)	Driver	Item-number	Colour	Colour	Colour	kg
Sample luminaire	LED 2400lm 840 LB	20	ED	543 3044 10...	■ ...5	□ ...1	■ ...4	3
	LED 4500lm 840 LB	41	DALI	543 3144 10...	■ ...5	□ ...1	■ ...4	3

P_{sys} | Lighting system performance

Driver

- ED | Electronic Driver, non dimmable
- DALI | Electronic Driver, DALI, dimmable
- DALI DT8 | Electronic Driver, DALI, dimmable, adjustable light colour
- Tast dim | dimmable via push button
- NL-B | Emergency light battery powered

Colour code/colour

- | aluminium natural anodized
- | traffic white (similar RAL 9016)
- wa | withe-aluminium (similar RAL 9006)
- | deep black (similar RAL 9005)
- sg | silver grey
- | stainless steel
- cr | chrome
- si | silver
- tc | translucent
- cl | clear
- gr | grit grey







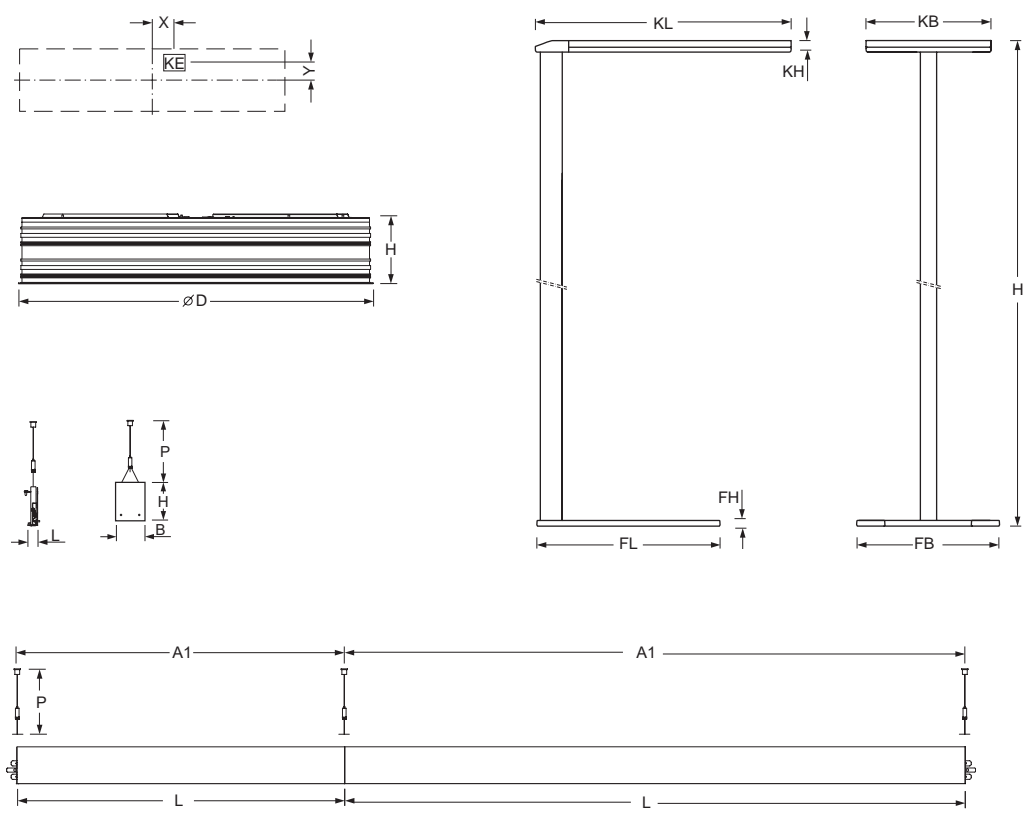







▶ Please refer to the current data for LED luminaires at www.lichtwerk.de

INDEX



Definition of measurement table variants

- L | Length
- L | Length/Width for square luminaires
- L2 | Additional length
- B | Width
- H | Height
- ∅D | Diameter
- FL | Length of luminaire base
- FB | Width of luminaire base
- FD | Diameter of luminaire base
- T | Depth
- KE | Cable infeed
- KL | Length of luminaire head or ballast box
- KB | Width of luminaire head or ballast box
- KH | Height of luminaire head or ballast box
- KD | Diameter of luminaire head or ballast box
- A1 | Fixing distance in case of single mounting
- A2 | Fixing distance between the luminaires in case of light run mounting
- X | Distance from centre of the luminaire to the electrical feed in (x direction = length)
- Y | Distance from centre of the luminaire to the electrical feed in (y direction = width)
- SL | Length of cut for recessed luminaires
- SB | Width of cut for recessed luminaires
- SD | Diameter of cut for recessed luminaires
- e | Minimum necessary depth for luminaire mounting
- ML | Modul (axis) Length
- MB | Modul (axis) Width
- P | Wire suspension
- P min/max | Min./Max. length wire suspension
- DS min/max | Min./Max. ceiling thickness in case of suspended ceiling
-  | for ceilings with visible T-rails
-  | for cut-out ceilings

- Recessed luminaires 
- Surface mounted luminaires 
- Pendant luminaires 
- Phase-track and luminaires 
- Lighting systems 
- Downlights 
- Wall luminaires Standing luminaires 
- Light furniture 
- Glass luminaires 
- Control Information 





WALL- AND STANDING LUMINAIRES



Wall- and standing luminaires

Wall luminaires from other chapters



Surface mounted luminaires



galant-pro-GPAK

P. 124



galant-pro-GPAKPC

P. 128

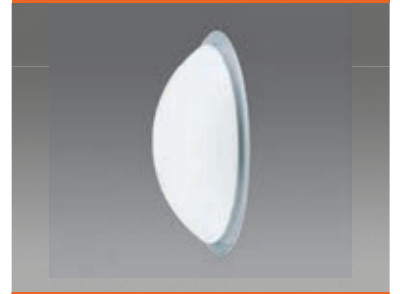

drop

P. 132



Glass luminaires



syrma-W

P. 420

INDEX



serio-WIFA

P. 388



rason-RSWG

P. 392



rason-RSSIMP

P. 396



scala-AG

P. 142



linar image II-AMP

P. 146



linar image II-AG

P. 150



corona-A

P. 428



puck-A

P. 436



dyski-A

P. 444

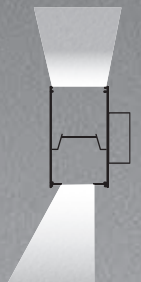
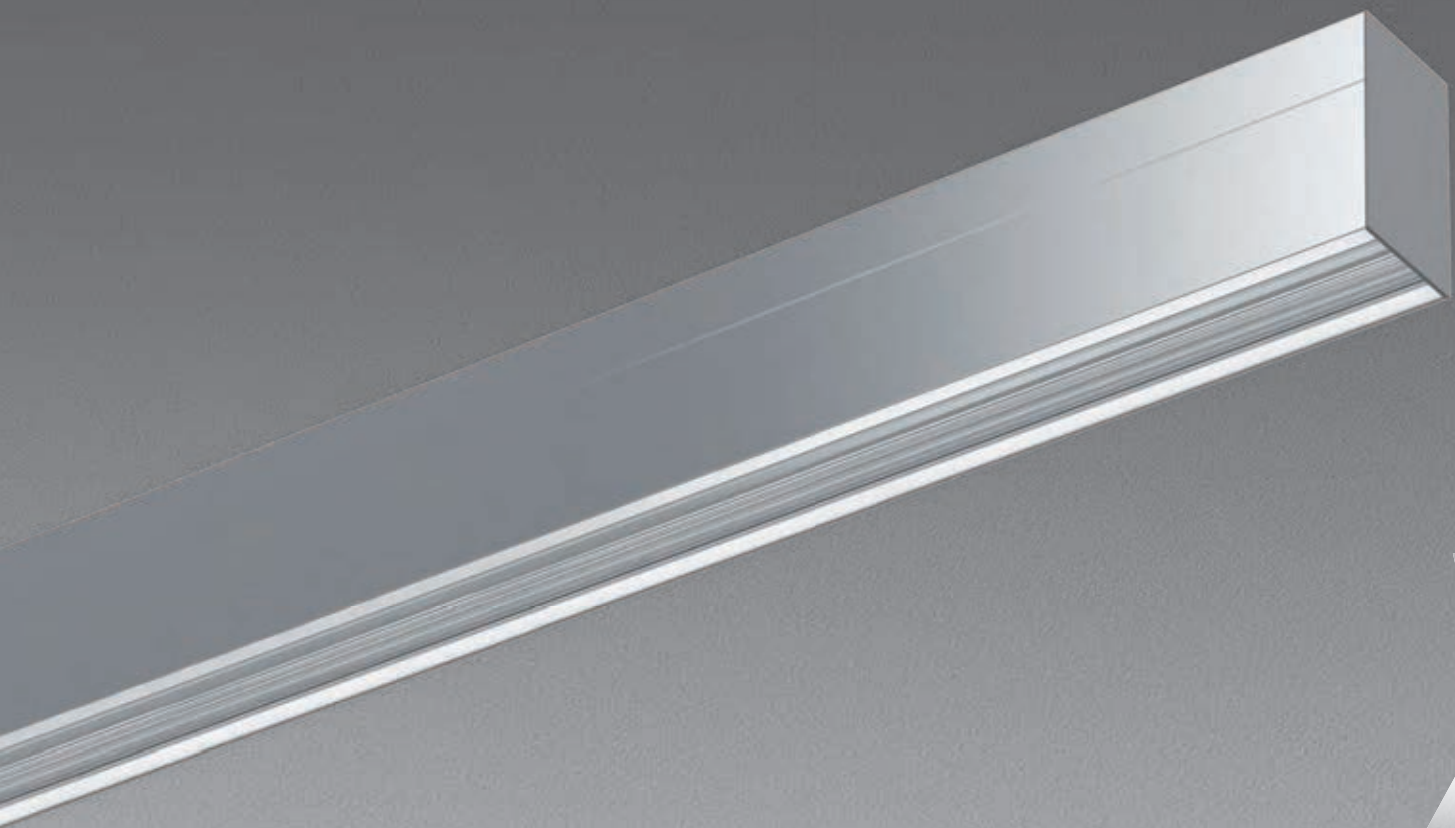

serio-WIFA

IP20    

Housing

Aluminium profile, natural anodised. Face ends sheet steel, painted white aluminium. Also available in textured paint traffic white (similar to RAL 9016) or deep black (similar to RAL 9005). Other housing colours on request.

Lighting technology -WIFA

Direct/indirect distribution, DALI variant separately dimmable.
Direct asymmetric light distribution via Fresnel lens made from acrylic.
Indirect share via white-opal, satin-finished acrylic profile.
Rated life time = L80 B10 50.000h.
Light colour: 4000K. Optional: 3000K. Other light colours on request.

Miscellaneous

Electrical connection via 3-pole, for dimmable luminaires 5-pole connection terminal with plug-in contacts; with integrated protective earth conductor connection and release button, suitable for rigid and flexible conductors up to 2.5mm².

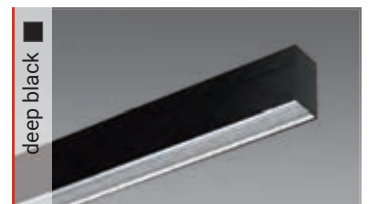

Type	L	B	T	H	A1	X	Y
serio-WIFA/0500	567	61	86	106	330	238	72
serio-WIFA/0800	847	61	86	106	610	0	72
serio-WIFA/1100	1127	61	86	106	890	0	72
serio-WIFA/1400	1407	61	86	106	1170	0	72
serio-WIFA/2200	2247	61	86	106	2010	0	72
serio-WIFA/2800	2807	61	86	106	2570	0	72

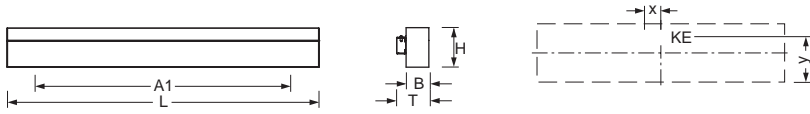

serio-WIFA/1400
8100lm 840

η_{LB}	100 %
Direct	44 %
Indirect	56 %
UGR lat.	22,3
UGR long.	20,3

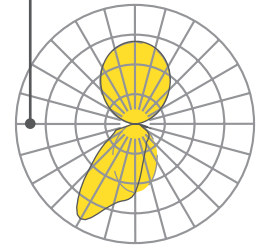

Type	LED Specification	P _{sys} (W)	Driver	Item-number	Colour	Colour	Colour	kg
serio-WIFA/0500	LED 3200lm 840	27	ED	443 2144 18...	■ ...0	□ ...1	■ ...4	3,0
	LED 3200lm 840	27	DALI	443 2146 68...	■ ...0	□ ...1	■ ...4	3,0
serio-WIFA/0800	LED 4700lm 840	41	ED	443 3144 18...	■ ...0	□ ...1	■ ...4	4,2
	LED 4700lm 840	41	DALI	443 3146 68...	■ ...0	□ ...1	■ ...4	4,2
serio-WIFA/1100	LED 6300lm 840	54	ED	443 4144 18...	■ ...0	□ ...1	■ ...4	5,7
	LED 6300lm 840	54	DALI	443 4146 68...	■ ...0	□ ...1	■ ...4	5,7
serio-WIFA/1400	LED 8100lm 840	69	ED	443 5144 18...	■ ...0	□ ...1	■ ...4	6,9
	LED 8100lm 840	69	DALI	443 5146 68...	■ ...0	□ ...1	■ ...4	6,9
serio-WIFA/2200	LED 12600lm 840	108	ED	443 8144 18...	■ ...0	□ ...1	■ ...4	11,3
	LED 12600lm 840	108	DALI	443 8146 68...	■ ...0	□ ...1	■ ...4	11,3
serio-WIFA/2800	LED 16200lm 840	139	ED	443 0144 18...	■ ...0	□ ...1	■ ...4	13,0
	LED 16200lm 840	139	DALI	443 0146 68...	■ ...0	□ ...1	■ ...4	13,0

► Please refer to the current data for LED luminaires at www.lichtwerk.de







rason-RSWIG

IP20 ⊕ ∇ ↕ CE

Housing

Ultra-flat luminaire housing, aluminium profile, natural anodised, visible construction height 30mm; with continuous longitudinal groove, rounded towards the front of the luminaire.

Suitable for wall- and ceiling-mounting.

Lighting technology -RSWIG

Direct/indirect distribution.

Homogeneous illumination by satinised special acrylic panel, with high transmission; homogeneous light emission through lateral LED light coupling and fitted aluminium reflector in a highly reflective white coating, with micro-perforation for a moderate wall illumination.

Rated life time = L80 B10 50.000h.

Light colour: 4000K. Optional: 3000K. Other light colours on request.

Miscellaneous

Electrical connection via three-pole or for dimmable luminaires, five-pole feed-in and connection terminal with plug-in technology, with integrated protective earth connection and unlocking button, suitable for rigid and flexible cables up to 2,5mm².



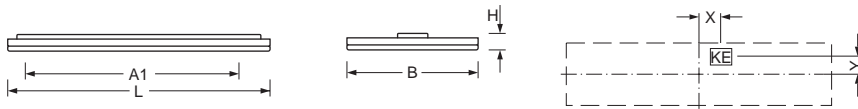

Type	L	B	H	A1	X	Y
rason-RSWIG/355	355	330	42	265	0	0
rason-RSWIG/635	635	330	42	548	0	0

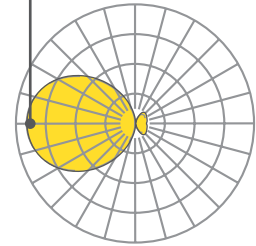

rason-RSWIG/635
2600lm 840

η_{LB}	100 %
Direct	84 %
Indirect	16 %
UGR lat.	20,4
UGR long.	20,3



Type	LED Specification	$P_{sys}(W)$	Driver	Item-number	Colour	 kg
rason-RSWIG/355	LED 1300lm 840	12	ED	460 1034 115		2,4
rason-RSWIG/635	LED 2600lm 840	24	ED	461 1044 115		4,2
	LED 2600lm 840	24	DALI	461 1046 615		4,2

► Please refer to the current data for LED luminaires at www.lichtwerk.de







rason-RSIMP

IP20     

Housing

Standing luminaire with ultra-flat head. Luminaire head and column made of an extruded aluminium profile, natural anodized. Black switch. Stable, sand-cast base coloured black. Base coloured white aluminium available on request.

Lighting technology -RSSIMP

Direct/indirect light distribution.

Direct ratio glare control via PMMA microprism pane. Indirect ratio via special acrylic pane.

For VDU workstations $65^\circ < 3000\text{cd/m}^2$, $\text{UGR} \leq 19$ according to DIN EN 12464-1.

Rated life time = L80 B10 50.000h.

Light colour: 4000K. Optional: 3000K. Other light colours on request.

Tast dim

Direct and indirect ratio dimmable separately via integrated push button, 230V.

DALI M5S5

Luminaire master unit equipped with controller LC-OM DALIeco and sensor LC-OM DALIeco LS/PD LI for daylight and presence-dependent control. Direct and indirect ratio dimmable separately via integrated push button.

Miscellaneous

2,85m connection cable, black, with safety plug.

Accessories

Infrared remote control LC-OM Master Remote Kit for commissioning and infrared remote control LC-OM User Remote for operating the DALI M5S5 luminaire. Light control systems must be ordered separately.

Type	H	FL	FB	FH	KL	KB	KH
rason-RSSIMP	1950	490	380	18	680	330	30

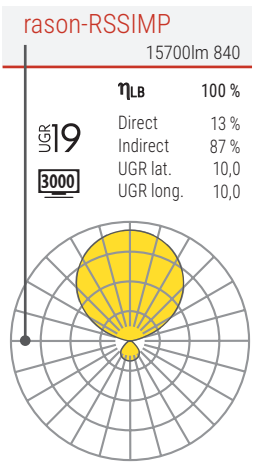
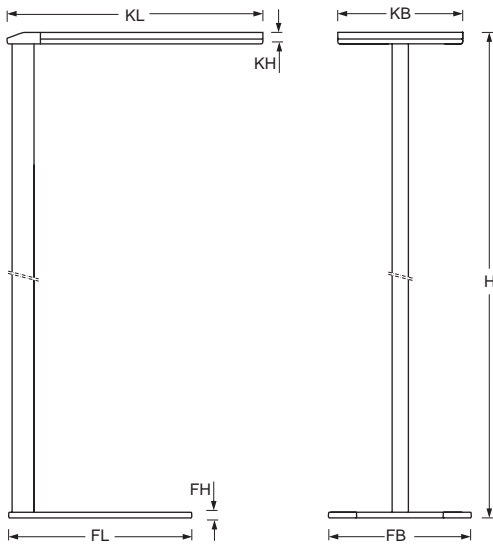

Type	LED Specification	P _{sys} (W)	Driver	Item-number	Colour	kg
rason-RSSIMP	LED 15700lm 840	103	ED	471 1304 175	■	18,4
	LED 15700lm 840	103	Tast dim	471 1306 575	■	18,4
	LED 15700lm 840	103	DALI M5S5	471 1308 175	■	18,4

► Please refer to the current data for LED luminaires at www.lichtwerk.de



Accessories	Type	Details	Item-number	Colour	kg
Light Control	LC-OM Master Remote PC Kit	Remote control IR for commissioning the DALIeco (M5S5) light control system	850 1041 100	■	0,11
	LC-OM User Remote	Remote control IR for the operation of the DALIeco (M5S5) light control system	850 1042 100	□	0,11





Photo index

Page	Photographer	Project
Cover	designed by almumtazza	Freepik.com
002 - 003	s.h.schroeder; Köln DE	World Conference Center; Bonn DE
008 - 009	lichtwerk GmbH; Königsberg DE	Gustav-Heinemann-Schule; Rastatt DE
012 - 013	lichtwerk GmbH; Königsberg DE	Harter Gebäudetechnik GmbH; Gerolzhofen DE
016 - 017	lichtwerk GmbH; Königsberg DE	Haßberg Kliniken; Haßfurt DE
020 - 021	Jake Campell, Kiel DE	Heinrich-Heine-Schule, Büdelsdorf DE
024 - 025	lichtwerk GmbH; Königsberg DE	Universität; Bayreuth DE
028 - 029	lichtwerk GmbH; Königsberg DE	Maria Ward Schule; Bamberg DE
032 - 033	lichtwerk GmbH; Königsberg DE	Maria Ward Schule; Bamberg DE
036 - 037	lichtwerk GmbH; Königsberg DE	Waldi Schuhfabrik, Haßfurt DE
040 - 041	lichtwerk GmbH; Königsberg DE	ZF Sachs; Schweinfurt DE
044 - 045	lichtwerk GmbH; Königsberg DE	Rendering
048 - 049	Jana Wenderoth; Kassel DE	Zahnarztpraxis Dr. Claar, Kassel DE
052 - 053	lichtwerk GmbH; Königsberg DE	Musikakademie, Hammelburg DE
056 - 057	lichtwerk GmbH; Königsberg DE	Realschule; Mellrichstadt DE
060 - 061	lichtwerk GmbH; Königsberg DE	Zahnarztpraxis Fronemann & Spitzl; Veitshöchheim DE
064 - 065	lichtwerk GmbH; Königsberg DE	Maria Ward Schule; Bamberg DE
066 - 067	lichtwerk GmbH; Königsberg DE	Musikakademie; Hammelburg DE
070 - 071	shutterstock; ImageFlow	Rendering lichtwerk GmbH; Königsberg DE
076 - 077	shutterstock; ImageFlow	Rendering lichtwerk GmbH; Königsberg DE
082 - 083	lichtwerk GmbH; Königsberg DE	BAUR Versand GmbH; Weismain DE
086 - 087	lichtwerk GmbH; Königsberg DE	BAUR Versand GmbH; Weismain DE
090 - 091	Jan-Eric Winkelmann; Rostock DE	Ernst-Moritz-Arndt Universität; Greifswald DE
094 - 095	Jana Wenderoth; Kassel DE	Werner-Wicker-Klinik; Reinhardshausen DE
100 - 101	Jana Wenderoth; Kassel DE	Werner-Wicker-Klinik; Reinhardshausen DE
104 - 105	Frank Freihofer; Kitzingen DE	Technologie und Gründerzentrum; Würzburg DE
110 - 111	uligraphics; Lichtenfels DE	Bodycare; Forchheim DE
114 - 115	Steffen Spitzner; Gera DE	Centogene; Rostock DE
118 - 119	Steffen Spitzner; Gera DE	Erwin-Fischer-Schule; Greifswald DE
122 - 124	Inga Paas; Köln DE	Goldener Ring; Düsseldorf DE
126 - 127	BSD Agentur; Mainz DE	Rendering
130 - 131	Gerhard Hagen; Bamberg DE	Fichtelgebirgsrealschule; Marktredwitz DE
134 - 135	lichtwerk GmbH; Königsberg DE	Schwimmbad; Königsberg DE
138 - 139	lichtwerk GmbH; Königsberg DE	Maria Ward Schule; Bamberg DE
140 - 141	lichtwerk GmbH; Königsberg DE	Maria Ward Schule; Bamberg DE
144 - 145	Steffen Spitzner; Gera DE	Erwin-Fischer-Schule; Greifswald DE
148 - 149	lichtwerk GmbH; Königsberg DE	Fränkische Rohrwerke; Königsberg DE
152 - 152	lichtwerk GmbH; Königsberg DE	Zahnarztpraxis Dr. Ambros; Knetzgau DE
153 - 153	lichtwerk GmbH; Königsberg DE	SRAM; Schweinfurt DE
160 - 161	shutterstock; ImageFlow	Rendering lichtwerk GmbH; Königsberg DE
172 - 173	lichtwerk GmbH; Königsberg DE	Rathaus; Knetzgau DE
182 - 183	istock; Peshkova	Rendering lichtwerk GmbH; Königsberg DE
186 - 187	lichtwerk GmbH; Königsberg DE	Musikakademie, Hammelburg DE
190 - 191	lichtwerk GmbH; Königsberg DE	Singer Ingenieur Consult GmbH; Bamberg DE
194 - 195	lichtwerk GmbH; Königsberg DE	Harter Gebäudetechnik GmbH; Gerolzhofen DE
198 - 199	lichtwerk GmbH; Königsberg DE	Harter Gebäudetechnik GmbH; Gerolzhofen DE
202 - 203	lichtwerk GmbH; Königsberg DE	AWT; Werneck DE
206 - 207	s.h.schroeder; Köln DE	World Conference Center; Bonn DE
210 - 211	lichtwerk GmbH; Königsberg DE	AUTARKIC; Eggolsheim DE
214 - 215	lichtwerk GmbH; Königsberg DE	Stadtwerke; Bad Kissingen DE
218 - 219	lichtwerk GmbH; Königsberg DE	Sanitätshaus Traub; Schweinfurt DE
222 - 223	lichtwerk GmbH; Königsberg DE	SRAM; Schweinfurt DE



Page	Photographer	Project
226 - 227	lichtwerk GmbH; Königsberg DE	Otto-Friedrich-Universität; Bamberg DE
230 - 231	lichtwerk GmbH; Königsberg DE	Otto-Friedrich-Universität; Bamberg DE
234 - 235	Oliver Kutzy; Lübeck DE	Stadtwerke; Neustadt DE
238 - 239	lichtwerk GmbH; Königsberg DE	Arztpraxis Dr. Schorb; Haßfurt DE
240 - 241	lichtwerk GmbH; Königsberg DE	Möbel Wolf; Schweinfurt DE
245 - 245	lichtwerk GmbH; Königsberg DE	Singer Ingenieur Consult GmbH; Bamberg DE
248 - 249	iStock; Explora_2005	Rendering lichtwerk GmbH; Königsberg DE
254 - 255	iStock; Explora_2005	Rendering lichtwerk GmbH; Königsberg DE
258 - 259	lichtwerk GmbH; Königsberg DE	Wolf Möbel; Schweinfurt DE
262 - 263	H. Kaufmann; Euro Unitech Wien AT	BRUCHA; Michelhausen DE
	lichtwerk GmbH; Königsberg DE	Möbel Wolf; Schweinfurt DE
268 - 269	lichtwerk GmbH; Königsberg DE	Singer Ingenieur Consult GmbH; Bamberg DE
272 - 273	Jens Arbogast; Graben-Neudorf DE	Pneu Matthy GmbH; Karlsruhe DE
276 - 277	lichtwerk GmbH; Königsberg DE	Möbel Wolf; Schweinfurt DE
278 - 279	lichtwerk GmbH; Königsberg DE	Göhring Innenarchitektur; Lichtenfels DE
284 - 285	lichtwerk GmbH; Königsberg DE	BAUR Versand GmbH; Weismain DE
286 - 287	lichtwerk GmbH; Königsberg DE	Musikakademie, Hammelburg DE
310 - 311	lichtwerk GmbH; Königsberg DE	AWT; Werneck DE
314 - 315	lichtwerk GmbH; Königsberg DE	Musikakademie, Hammelburg DE
326 - 327	lichtwerk GmbH; Königsberg DE	Die Energie, Veitshöchheim DE
328 - 329	lichtwerk GmbH; Königsberg DE	Musikakademie, Hammelburg DE
340 - 341	lichtwerk GmbH; Königsberg DE	Arztpraxis Dr. Schorb; Haßfurt DE
342 - 343	lichtwerk GmbH; Königsberg DE	Göhring Innenarchitektur; Lichtenfels DE
354 - 355	lichtwerk GmbH; Königsberg DE	SRAM; Schweinfurt DE
356 - 357	Inga Paas; Köln DE	Gemeindezentrum DIE ARCHE; Wüstenrot DE
364 - 365	Boris Golz; Arnsberg DE	IGS - Integrierte Gesamtschule; Nienburg DE
368 - 369	Jana Wenderoth; Kassel DE	Hürner Funken GmbH; Mücke DE
372 - 373	lichtwerk GmbH; Königsberg DE	Optik Demmler; Bamberg DE
376 - 377	Jörg Wenderoth; Baunatal DE	Vom Fass; Kassel DE
380 - 381	Jana Wenderoth; Kassel DE	Firmenzentrale medDV; Fernwald DE
384 - 385	lichtwerk GmbH; Königsberg DE	Zahnarztpraxis Dr. Wenzel; Ringheim DE
390 - 391	lichtwerk GmbH; Königsberg DE	AWT; Werneck DE
394 - 395	lichtwerk GmbH; Königsberg DE	Regiolux GmbH; Königsberg DE
398 - 399	lichtwerk GmbH; Königsberg DE	Rendering
400 - 401	Tom Reindel; Düsseldorf DE	Medienhafen; Düsseldorf DE
406 - 407	Tom Reindel; Düsseldorf DE	Medienhafen; Düsseldorf DE
410 - 411	Inga Paas; Köln DE	Wiehler Wasserwelt; Wiehl DE
414 - 415	Inga Paas; Köln DE	Wiehler Wasserwelt; Wiehl DE
416 - 417	Danny Gohlke; Rostock DE	DJH Prora; Rügen DE
422 - 423	Frank Freihofer; Kitzingen DE	Pfarrzentrum; Limbach DE
426 - 427	Frank Freihofer; Kitzingen DE	Pfarrzentrum; Limbach DE
430 - 431	S. Meyer Architekturfotografie; Berlin DE	Gemeindezentrum; Stammheim DE
434 - 435	lichtwerk GmbH; Königsberg DE	Straßenmeisterei; Forchheim DE
438 - 439	lichtwerk GmbH; Königsberg DE	Straßenmeisterei; Forchheim DE
442 - 443	S. Meyer Architekturfotografie; Berlin DE	Gemeindezentrum; Stammheim DE
446 - 447	Frank Freihofer; Kitzingen DE	Pfarrzentrum; Limbach DE
450 - 451	S. Meyer Architekturfotografie; Berlin DE	Gemeindezentrum; Stammheim DE
454 - 455	lichtwerk GmbH; Königsberg DE	Rathaus; Knetzgau DE
468 - 469	lichtwerk GmbH; Königsberg DE	Maria Ward Schule; Bamberg DE



GTC - Sales and delivery conditions

1. General

1.1 These conditions of sale apply exclusively to companies, legal persons under public law or public-law special assets in the sense of § 310 paragraph 1 BGB (German Civil Code). The following conditions of sale apply exclusively for all offers and contracts regarding the delivery of goods by lichtwerk GmbH. They also apply for all future transactions with the Orderer when dealing with legal transactions of the related kind. The Orderer recognises the conditions as binding for him for all of the business relations. Modifications and amendments must be in written form. Conflicting or deviating terms and conditions of the Orderer are not terms of the contract, even if we do not expressly object to them. This will only be content of the respective contract in cases where we expressly approve the conflicting or deviating terms and conditions in writing.

1.2 We reserve our own rights of ownership, copyright and other intellectual property rights for all cost estimates, drawings and documents that are handed over to the Orderer during the contract negotiations. They may only be disclosed to third parties with our prior written permission. If an order is not issued, all transferred documents shall be returned immediately at our request. The Orderer does not have the right to use, retain or disseminate these documents.

2. Conclusion of the contract and scope of services

2.1 Our offers are not-binding and without obligation. In terms of the nature and scope of delivery, they will first be binding upon our written order confirmation. If an order is to be regarded as an offer according to § 145 BGB, we can accept this within two weeks by sending an order confirmation.

2.2 Verbal agreements, in particular supplementary agreements and commitments made by our employees, require our written confirmation to be effective.

2.3 For the delivery, we reserve the right to deviations of goods compared to the documents belonging to the offers, such as catalogues, illustrations, descriptions, drawings as well as weight and dimension information, provided they are commercial and reasonable for the Orderer and in particular do not impair quality and function.

3. Prices, deliveries and terms of payment

3.1 Prices and delivery

3.1.1 The prices are calculated in Euro exclusive of the legal VAT, which is invoiced separately according to the valid rate. The prices are calculated according to the prices valid at date of contract conclusion; if the delivery is made more than 4 months after contract conclusion, the prices valid at date of delivery can be invoiced.

3.1.2 Principally, prices shall be ex works excluding VAT, packaging, freight costs and insurance.

3.1.3 For a net order value of €1,500.00 or more, we deliver to the delivery location free of charge within Germany, whereby we provide the goods at the delivery location ready for unloading. Starting at € 750.00, we charge half of the transportation charges for a delivery location within Germany. For a net order value below € 250.00, we charge an additional small-volume surcharge of €25.00.

3.2 Terms of payment

3.2.1 Our invoices are to be paid within 30 days from the date of the invoice. For payment within eight days from the invoice date, we grant a 2 % discount. A payment is considered effected if we are able to access the funds. In the case of payment by cheque, payment is only considered effected when the cheque is redeemed by us.

3.2.2 The acceptance of cheques shall only be accepted on account of performance.

3.2.3 The Orderer's right of retention, as far as it is not based on the same contractual relationship, and the offsetting with contested and not legally determined claims is excluded.

3.2.4 If the Orderer is in default of payment as a whole or a part, he is bound - notwithstanding all other rights of the supplier - to pay from that point of time on default interests to the amount of 8 % annually above the base lending rate.

3.2.5 If the Orderer ceases payments or if bankruptcy is filed or mature checks or bills of exchange are not redeemed, all claims made by the supplier are immediately due.

4. Delivery times and acceptance obligations

4.1 The delivery period begins with the date of written agreement about the order between Orderer and supplier.

4.2 Hindrances beyond our responsibility, in particular acts of God, war, insurrection, strikes, transport disruptions, business disruptions, lack of material, official orders and other inevitable events that delay the delivery in whole or in part automatically lengthen the delivery period by the duration of such conditions. In such cases the parties have the right to withdraw from the contract in whole or in part.

4.3 In the event of a delayed delivery for which we are responsible, the Orderer can only assert his rights arising from the delay if the grace period he granted us has passed without result. If the Orderer proves in this case that he has incurred damages caused by the delay, he can claim a delay compensation for each completed week of the delay in the amount of 0.5% for the entire duration of the delay, but not to exceed 5% of the value of the goods not delivered on time. The right of the Orderer for exercising the right of withdrawal shall remain unaffected. Further-reaching claims shall only apply in cases of intent or gross negligence where liability is mandatory.

4.4 We are entitled to make reasonable installment deliveries.

4.5 If the Orderer causes a delay of dispatch or delivery of the goods or if the Orderer is otherwise in default in accepting the delivery of goods or should the Orderer intentionally violate other obligations to co-operate, we then have the right to claim compensation for any incurred damages in this respect, including any possible additional expenditure. Rights remain reserved for more extensive claims. Insofar as such aforesaid conditions apply, the risk of accidental loss or accidental deterioration of the purchased goods passes over to the Orderer at the precise point of time in which he is in default of acceptance or payment.

5. Dispatch, transfer of risk, returns

5.1 The risk is passed on to the Orderer when the goods leave the factory or a warehouse. Shipping takes place uninsured at the Orderer's risk. This also applies even if free delivery is agreed and also for deliveries by our transport staff. If the shipment is delayed as a result of circumstances for which the Orderer is responsible, the risk is transferred with our notification of readiness for shipment. If the shipment is delayed at the Orderer's request or at the fault of the Orderer, then we will store the goods at the Orderer's expense. The Orderer is required to check without delay whether the goods have been damaged during transportation and to immediately inform the carrier and deliverer of any damage or loss. Shipping takes place on behalf of the Orderer.

5.2 If the supplier has no statutory obligation to accept returned goods, the Orderer may only return goods with our express written consent and provided that they are undamaged and returned in the original packaging. 30% of the invoiced amount will be deducted from the credit note to cover processing costs. All reprocessing, freight, insurance and packaging costs are charged to the Orderer. Principally, it is not possible to return custom-made products.

6. Retention of Title

6.1 The goods remain our property until the fulfilment of all our entitled claims against the Orderer (goods subject to retention of title), even if the individual goods have been paid for. A pledge or chattel mortgage of the reserved goods is not permissible.

6.2 In the case of the permissible resale of the reserved goods within the ordinary course of business, the Orderer assigns us already now, until payment of all our claims, as collateral for its future claims towards his customers resulting of such resale without requiring any specific further explanations. This assignment also covers balance claims resulting from existing current account relationships or at their termination of the Orderer with his customers. If the reserved goods are sold together with other goods without agreeing upon an individual price for the reserved goods, the Orderer assigns us the priority over the other claims for such part of the total price claimed which corresponds to the value invoiced by us. Until revoked, the Orderer is authorized to collect the assigned demands from the resale, he is not entitled to dispose of them otherwise, e.g. by assignment. Upon our request, the Orderer must inform his customer about the assignment and to furnish us the necessary documents for the assertion of his rights towards the customer, e.g. to deliver invoices and to provide the required details.

6.3 If the purchaser does not meet all or a part of his payment obligations within 10 days after due date, if he does not cash due checks or if an application for insolvency is filed, we have the right to withdraw from the contract and to require the return of the goods. The purchaser is obliged to procure us with the possession of the goods. The Orderer grants us or any of our authorized representatives the access to all business premises during business hours. We are entitled to use the reserved goods with the diligence of a prudent businessman and to satisfy ourselves with the offsetting of open claims with their proceeds.

6.4 As long as the ownership has not been transferred, the Orderer is to inform us in writing immediately if the supplied item is seized or is exposed to other interventions by third parties. If the third party is unable to indemnify us for the costs of legal or out-of-court costs of a claim according to par.

771 ZPO (German Code of Civil Procedure), the Orderer is liable for our amount outstanding.

7. Warranty

7.1 We are liable for the defects of the goods (in the first instance under the exclusion of the Orderer's rights to back out of the contract or to reduce the purchase price) through rectification of the defect or replacement delivery at our choice. The Orderer shall grant us a reasonable time period to provide the rectification. If the supplementary performance does not work, the Orderer may basically according to his choice demand a cut of the compensation (decrease) or a cancellation of the contract. The improvement is considered failed after the second unsuccessful attempt, provided further improvement attempts are not appropriate due to the subject matter of the contract and are not reasonable to the Orderer. In case of a minor breach of contract, especially minor defects, the Orderer, however, does not have a right of cancellation.

7.2 Warranty rights of the Orderer require that the Orderer's obligations to make inspection and give notice of defects according to par. 377 HGB (German Commercial Code) have been properly fulfilled.

7.3 The Orderer must notify us concerning obvious defects within a period of 10 days after receipt of goods, otherwise the assertion of the warranty claim is excluded. Non-obvious defects must be claimed immediately when they are discovered or determined, otherwise they are deemed to be approved. For all presuppositions for claims he full burden of proof forlies with the Orderer, especially for the deficit itself, for the time period of the determination of the defect, and for the timeliness of the notice of defect.

7.4 If the Orderer, due to a deficiency in title or a material defect after failed subsequent performance, chooses to cancel the contract, he shall not be entitled to additional claims for damages due to the defect.

7.5 The warranty period amounts to one year from date of delivery of our goods to the Orderer.

7.6 The warranty obligation is void if the goods have suffered from improper handling or storage or if improper changes were made to them without the supplier's approval. We are not liable for subsequent changes to the lights, their internal circuitry, equipment or the lamps.

7.7 The condition of the goods only the product description of the manufacturer applies as agreed upon. Additional public statements or advertisements of the manufacturer do not represent a contractual statement on the nature of the goods.

7.8 In the event that the article of sale cannot be used by the Orderer as stipulated in the contract of sale as a result of negligent violation of collateral contractual duties, especially with regard to operating and maintenance instructions, we shall also be liable in accordance with paragraph 7.6.

In case of consulting we can only be held responsible if special payment was agreed in writing.

7.9 Claims made by the Customer against the Supplier for installation and disassembly costs, unless they serve to detect errors, costs of disposal and costs for hoisting devices and scaffolding shall be excluded. The Customer shall bear the costs of the necessary recommissioning, software reinstallation or software updates. Where the Supplier meets its cost absorption obligation pursuant to Article 478 of the German Civil Code with respect to other expenses necessary for supplementary performance, the Supplier shall be entitled to pay such expenses by means of a credit note for goods. A right to compensation for damages to the goods themselves shall be excluded. This does not apply, as far as compelling liability is given in cases of intent, gross negligence, lack of guaranteed product properties or the Product Liability Act.

8. Limitation on Liability

8.1 As far as it is not expressly stipulated otherwise in these conditions, the claims against us, our legal representatives and any person employed by us in the performance of our obligation and any vicarious agent resulting from damages, including consequential damages, which occur to the Orderer or a third party, in particular such damages resulting from fault at contract conclusion, culpable breach of an obligation and negligent and impermissible actions are excluded.

8.2 The aforesaid limitations of liability shall not affect the Orderer's product liability claims. In addition, we are liable for loss of life, physical injury and damage to health (regardless of existing limitation of liability according to the statutory provisions) that are caused by a negligent or wilful breach of duty on our part, our legal representatives or our assistants. We are liable under statutory provisions for damages that are not covered by clause 1 and that are based on fraudulent intent by us, our legal representatives or our assistants.

8.3 The Orderer's claim for damages for defect becomes time-barred after one year from date of delivery of the goods to the Orderer. This shall not apply if we can be accused of malice. In these cases, the statutory provisions apply.

9. Applicable law, place of jurisdiction

For these business relationships and all legal relationships between us and the Orderer, - including export contracts - the governing law of the Federal Republic of Germany applies exclusively. The application of the UN jurisdiction, concerning sales and purchase procedure, is excluded. If legally permissible, the place of jurisdiction for all disputes directly or indirectly resulting from a contractual relationship is, by our choosing, either Haßfurt or the court responsible for the Orderer's registered office. The place of fulfilment for deliveries and payments is also Haßfurt. If individual conditions of the contract including these GTC are partially ineffective or will be, the validity of the other conditions are not affected by it. The whole or partial ineffective condition should be replaced by conditions, whose economic purpose comes as close as possible to the ineffective one.



Contact

HEAD OFFICE KOENIGSBERG

SALES

T +49 9525 9827 0
info@lichtwerk.de

TECHNICAL SERVICE

T +49 9525 9827 1
lichtplanung@lichtwerk.de

GERMAN SALES FORCE

01 **MECKLENBURG-VORPOMMERN**
Gritt Schlemminger
M +49 151 14733968
gritt.schlemminger@lichtwerk.de

02 **HAMBURG, SCHLESWIG-HOLSTEIN**
Michael Brott
M +49 160 7177747
michael.brott@lichtwerk.de

Reinhard Froeschke
M +49 170 2089020
r.froeschke@froeschke-licht.de

03 **HANNOVER**
Ralf Reichel
M +49 160 7177738
ralf.reichel@lichtwerk.de

04 **SACHSEN**
Jörg Irmisch
M +49 172 8670062
joerg.irmisch@lichtwerk.de

Jürgen Bergmann
M +49 172 8670049
juergen.bergmann@lichtwerk.de

05 **THÜRINGEN**
Jens Schlothauer
M +49 151 14733955
jens.schlothauer@lichtwerk.de

06 **HESSEN**
Jörg Wenderoth
Industrial representation
Kirchweg 1
DE- 34225 Baunatal
T +49 5601 9999040
info@wenderoth-iv.de

07 **DÜSSELDORF**
Daniel Pangritz
M +49 160 7177745
daniel.pangritz@lichtwerk.de

Dominic Pauli
M +49 160 7177737
dominic.pauli@lichtwerk.de

08 **KOBLENZ**
Bernd Oedekoven GmbH
Industrial representation
Rudolf-Diesel-Straße 11
DE- 56220 Urmitz
T +49 2630 96350
info@oedekovengmbh.de

09 **RHEIN-MAIN**
Markus Schimmer
M +49 151 14733980
markus.schimmer@lichtwerk.de

10 **NORDBAYERN**
Peter Gröger
M +49 172 8670045
peter.groeger@lichtwerk.de

Stephan Althaus
M +49 160 7177731
stephan.althaus@lichtwerk.de

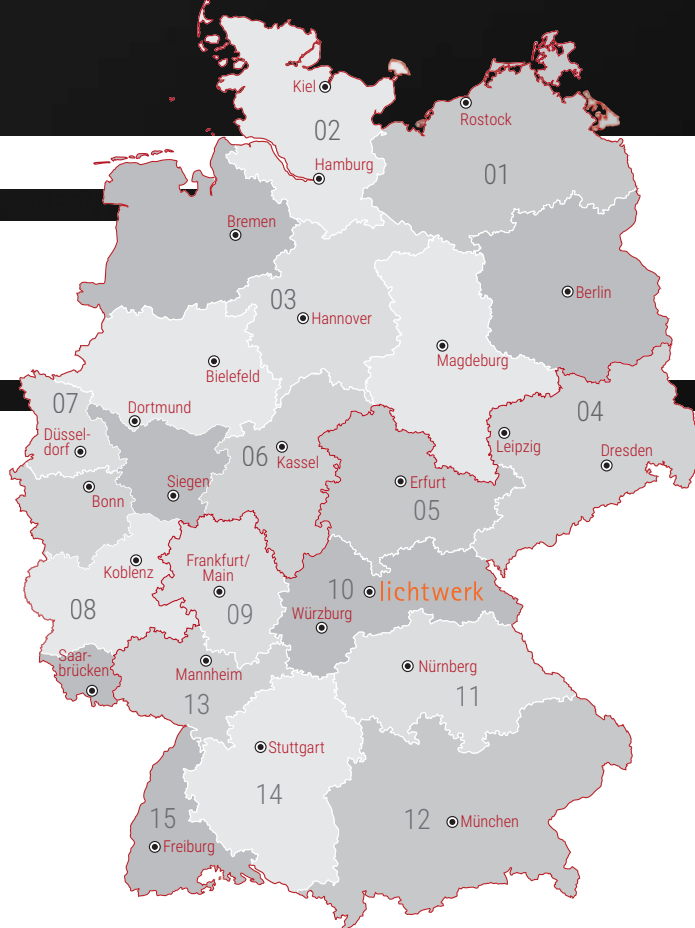

11 **BAYERN-MITTE**
Bernhard Zirkelbach
M +49 172 8670047
bernhard.zirkelbach@lichtwerk.de

12 **SÜDBAYERN**
Andrea Fleischmann
M +49 160 7177739
andrea.fleischmann@lichtwerk.de

Dieter Beier
M +49 151 14733958
dieter.beier@lichtwerk.de

13 **NORDBADEN**
Steffen Leuschel
M +49 160 7177740
steffen.leuschel@lichtwerk.de

14 **STUTTART**
Frank Bossert
Industrial representation
Hofenerweg 17
DE- 71686 Remseck
T +49 711 57766960
info@bossert-weissinger.de

15 **SÜDBADEN**
Fred Abel GmbH
Industrial representation
Im Ebnet 1
DE- 79238 Ehrenkirchen
T +49 7633 95010
info@fredabel.de

SALES INTERNATIONAL / SALES MANAGER

Torsten Kießlich-Köcher
T +49 9525 89450
F +49 9525 89444
M +49 172 8682620
torsten.kiesslich@lichtwerk.de

Australia, Canada, Cyprus, Estonia,
Greece, India, Ireland, Latvia, Lithuania,
New Zealand, Portugal, Romania, Russian
Federation/CIS, Slovenia, Spain, Ukraine,
United Kingdom, USA

Stefan Nestmann
T +49 9525 89438
F +49 9525 89444
M +49 172 8670054
stefan.nestmann@lichtwerk.de

Bulgaria, Czech Republic, Denmark,
Hungary, Netherlands, Poland, Slovakia

Reinhold Pfister
T +49 9525 89451
F +49 9525 89444
M +49 172 8670050
reinhold.pfister@lichtwerk.de

Austria, Croatia, Iceland, Montenegro,
Norway, Serbia, Switzerland

Daniel Hau
T +49 9525 89657
F +49 9525 89444
M +49 160 7177734
daniel.hau@lichtwerk.de

Belgium, Finland, France, Israel, Italy,
Luxembourg, Middle East, Morocco,
Sweden, Turkey

EXCLUSION OF LIABILITY

Illustrations, dimensions and weights in our catalogues, price lists and quotations are non-binding. Subject to technical changes, errors and color deviations. All luminaires have been designed for 230V 50Hz mains connection and ambient conditions according to DIN EN 60598 unless otherwise stated, and are supplied without lamps unless otherwise stated. Most of the indications with regard to certifications are presented in our catalogue in a general form. Verification with regard to products can be easily carried out on our website.

Because of the dynamics in the technical development especially in the field of LED modules and their drivers, the information in this paper can only be a snapshot of the current state and are therefore legally not binding. Please refer to our web site for current product specifications.

We point out that the orderer recognises our delivery and payment conditions unless he/she objects in writing when sending his/her order.

Registration number: DE 40859830

lichtwerk GmbH
Hellinger Straße 3
D 97486 Königsberg



www.lichtwerk.de

9999 2061 221 1A 600 05/21 LI/SCHL. Subject to modifications.